

Mechanism Components Cover Fabric

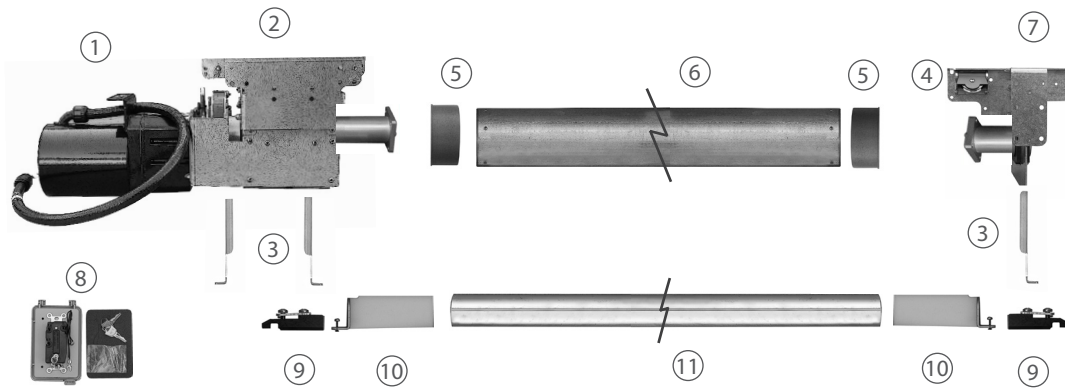

Cover Track Cover Lid Lid Support Bracket Cover Pump

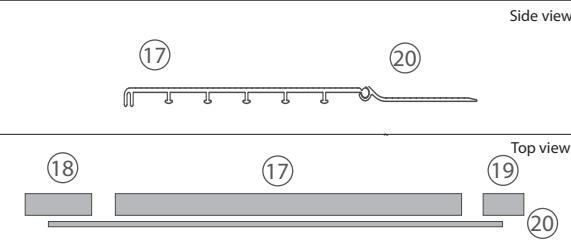
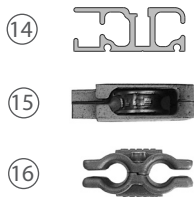

Parts List Misc. Hardware

- |   |   |
|---|---|
| <ol style="list-style-type: none"> <li>1. A1839 Motor &amp; housing, standard 3 wire Bison motor</li> <li>2. A1589 Mechanism RT or UT (Right)<br/>A1588 Mechanism RT or UT (Left)</li> <li>3. M4612 Mechanism Mounting Foot</li> <li>4. A0020 Non-motor end cone assembly</li> <li>5. A2374 Tube insert for 6" tube</li> <li>6. X0001 6" aluminum roll-up tube</li> <li>7. A1601 Non-motor end assembly RT/UT (Right)<br/>A1604 Non-motor end assembly RT/UT (Left)</li> <li>8. A0605 Key switch - Leviton assembly complete w/light</li> <li>9. A1100 Slider Assembly UT 403 &amp; 801 for detachable ropes</li> <li>10. A1688 Leading edge insert assembly UT 3"</li> <li>11. X0021 Aluminum leading edge</li> <li>12. Cover Cover fabric</li> <li>13. PowerFlex Rope - Varies with cover length</li> <li>14. A0614 403 Under Track, 21'</li> <li>15. A0958 Pulley end cap assembly 403 &amp; 801 UT</li> <li>16. A1884 Guide feed 2 piece SS UT</li> <li>17. X0004 Main Lid</li> <li>18. X0121 Motor End lid</li> <li>19. X0659 Non-motor end lid</li> <li>20. X0943 8" Lid hinge</li> <li>21. A1692 Standard cover lid bracket (set of 2)</li> <li>22. MH232 Little Giant cover pump &amp; instructions</li> <li>23. A0407 Under track retainer bracket set</li> <li>24. M0104 Track splice UT 403</li> </ol> | <ol style="list-style-type: none"> <li>25. E1086 Bonding lug copper (for 1 wire)</li> <li>26. H0332 Screw PPSM 12 x 1-3/4" for UT STD (screw on track)</li> <li>27. H0150 Parts kit cross brace joining screw</li> <li>28. H0152 Screw PPMS 10-32 x 1/2"</li> <li>29. H0176 Nut nylock 10-32</li> <li>30. H0075 Rope loop (black plastic)</li> <li>31. H0313 Screw HHWSM tek 10 x 1/2" SS</li> <li>32. H0324 Plastic anchor STD #12</li> <li>33. H0331 Screw HHWSM 12 x 1-1/2" w/slot</li> <li>34. H0294 Carriage bolt 1/4-20 x 3/4"</li> <li>35. E1098 Bonding wire</li> <li>36. H9630 Spring pin for track alignment</li> <li>37. H0276 Nut Nylock 1/4-20</li> <li>38. H0130 Screw PFMS 10-32 x 1"</li> <li>39. H1099 Screw PPMS 10-32 1-3/4"</li> <li>40. H9705 Bolt HH 1/4-20 x 1/2" SS</li> <li>41. H0001 Washer split lock 1/4"</li> <li>42. H0096 Bolt HH 3/8-16 x 1-1/4"</li> <li>43. H0004 Washer split lock 3/8"</li> </ol> |
|---|---|



The above parts list is typical for most pools up to 20' x 40' and includes all parts necessary to install the Coverstar system, however, parts will vary for longer or wider pools and according to your specific order.



## STANDARD UNDER TRACK

Step By Step Instructions	Page/Step
Step by step installation instructions.....	5/1

## Step by Step Instructions

Numbers in parenthesis refer to parts shown on page 3.

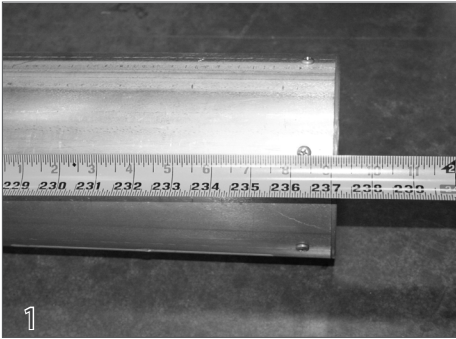

To determine if the cover system was ordered correctly for the pool, the length of the roll-up tube should be 3 inches shorter than the track space.

For example, for a 20 ft track space, the correct length of roll-up tube is 19 ft 9 in.



Cut the length of the track on each side of the pool so it will extend 1 inch past the end of the encapsulation into the cover box.



Before splicing the sections of track together, file all track ends thoroughly, rounding all edges and removing all burrs. Clean metal shavings from the track. This step is extremely important! If the track isn't filed smooth, damage can occur to the ropes, slider and cover.

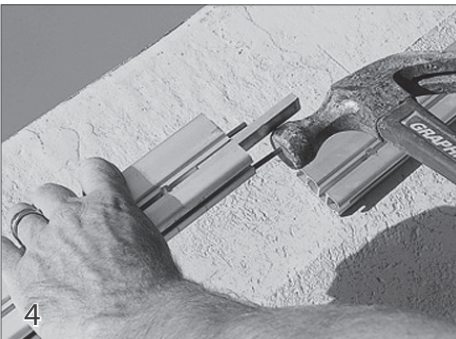

Tap the splice pins (39) into one end of the track and slide the center splice (24) into the center channel.



Lay the sections of track on the deck and tap them together using a rubber mallet so the center splice and splice pins interlock with each section of track.

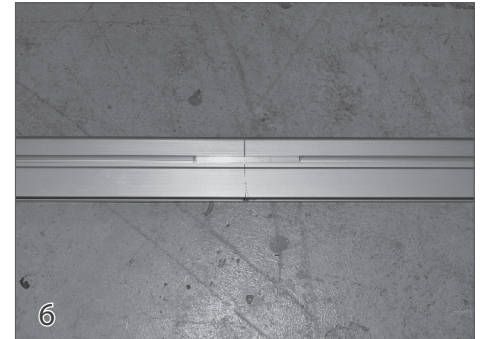

Continue tapping the end of the track until the two sections of track are tight together so there is not a gap from one track to the next.



When encapsulation is being used, the track is normally installed during the cover installation. (See *cover installation* section page 11, step 9).

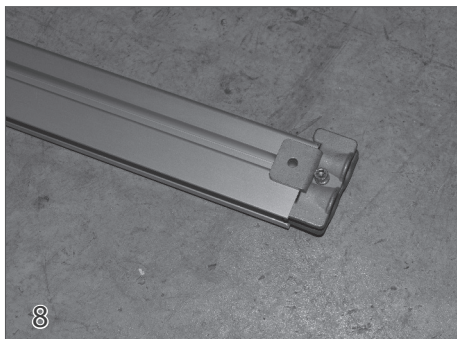

Using a 5/32" allen wrench, loosen the screw on the top of the guide feed (16). Insert the guide feed on the end of the track that will extend into the housing.



While holding the guide feed firmly, use a drill with a 3/16" bit to drill through the hole in the guide feed and through the track. Remove the guide feed. Do this for the track on both sides of the pool.



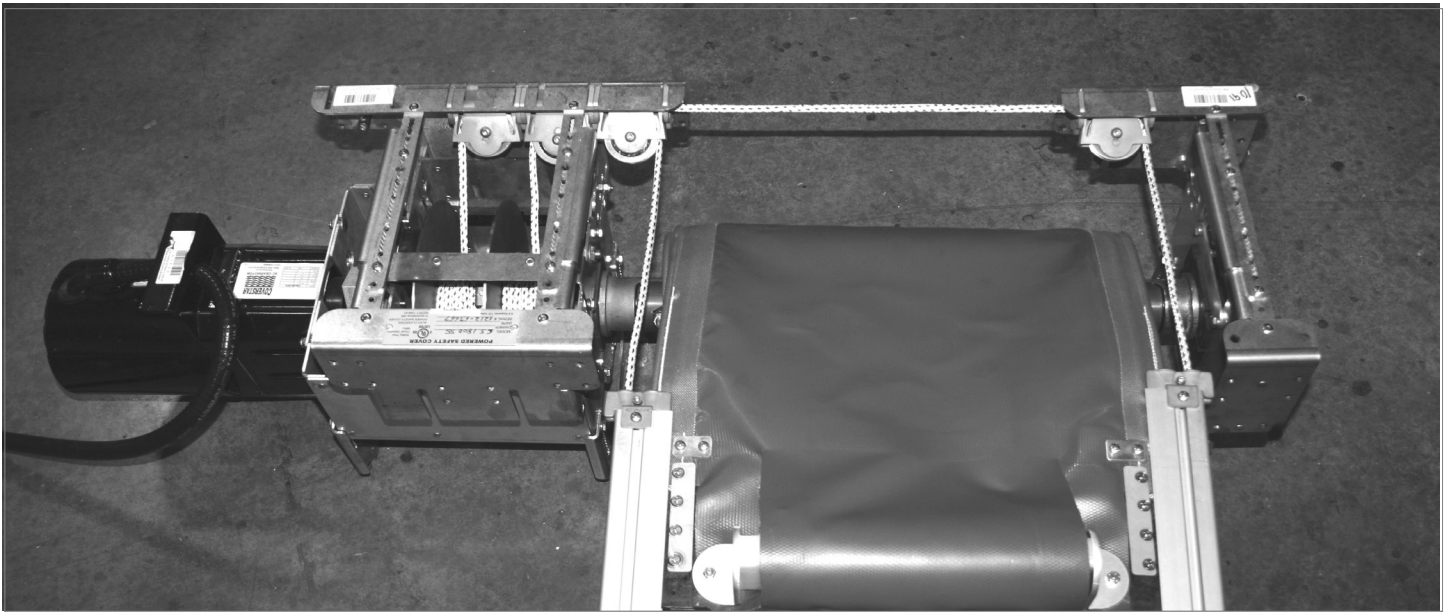

# MECHANISM

Step By Step Instructions	Page/Step
Cover Box preparation .....	7/1
Connecting the roll-up tube .....	7/2
Adjusting the mechanism height .....	7/4
Positioning the roll-up tube/mechanism ....	7/7
Anchoring the mechanism feet .....	8/12
Anchoring the pulley brackets.....	8/18
Wiring the electrical switch .....	9/20



## Step By Step Instructions

Numbers in parenthesis refer to parts shown on page 3.



### Cover Box Preparation

Use a garden hose to clean out the cover box. During this process, make sure the water is draining from the cover box. It is critical that all cover boxes have adequate drainage. Inadequate drainage may void the mechanism warranty. If there is no drain or inadequate drainage in the cover box, contact your Coverstar Representative.

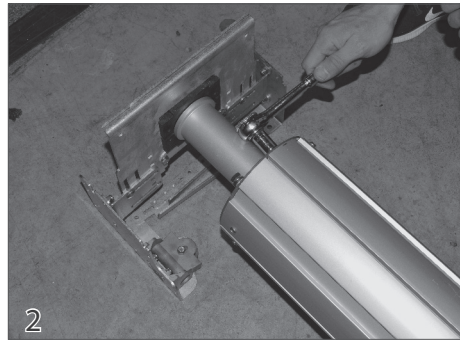

### Connecting the Roll-up Tube

With the non-motor end turned upside down, attach the cone for the non-motor end to the roll-up tube using the 3/8" x 1-1/4" bolts (36) and lock washers (37) provided.

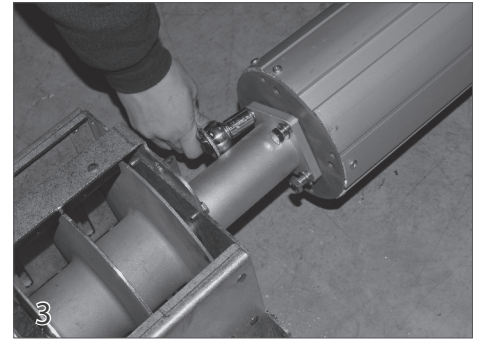

With the motor end turned upside down, attach the cone to the motor end of the mechanism using the 3/8" x 1-1/4" bolts (36) and lock washers (37) provided. Tighten these bolts with a 9/16" wrench.



### Adjusting Mechanism Height

Measure from the bottom of the housing to the top of the track. The top of the mechanism should be installed so it is at the same height as the top of the track. Because the top of the mechanism is adjustable, use the feet to position the roll up tube as high as possible in the cover box, but allowing clearance so the cover won't rub on the lid brackets.

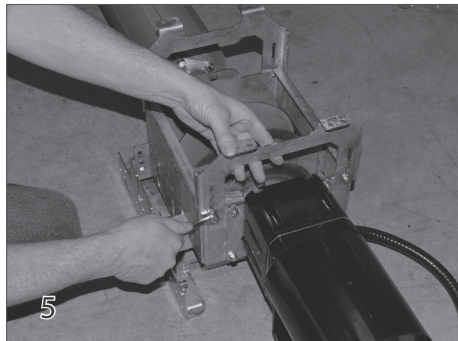

With the motor end positioned upside down, install the mounting feet using the bolts (47) and lock washers (48) provided.

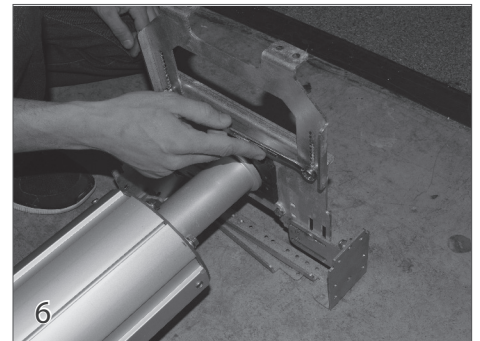

Install the mounting feet on the non-motor end using the bolts (47) and lock washers (48) provided. The top of the pulley bracket on the non-motor end should be flush with the top of the track.

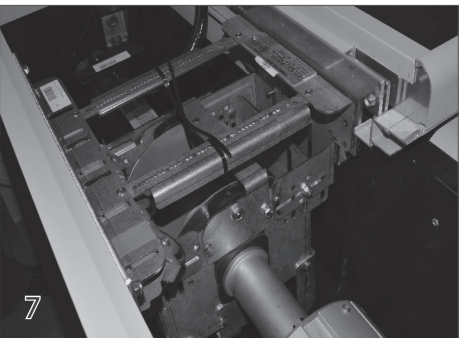

**Positioning the Mechanism** Lower the assembled mechanism with attached roll-up tube into the cover box and place it roughly in the position it will be anchored. Note: If the cover box isn't square to the pool, position the mechanism in the cover box so it will be square to the cover track.

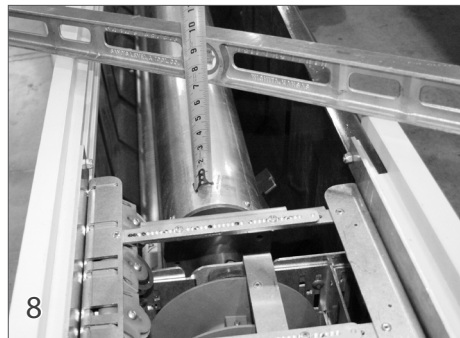

With the mechanism and tube assembled and set in place in the housing, check the roll-up tube for level. This is crucial to proper operation of the cover. Position a level across the housing. Measure from the roll-up tube to the bottom of the level on both the motor end and non-motor end of the mechanism. Adjust height of the non-motor end feet if needed to level the roll-up tube.

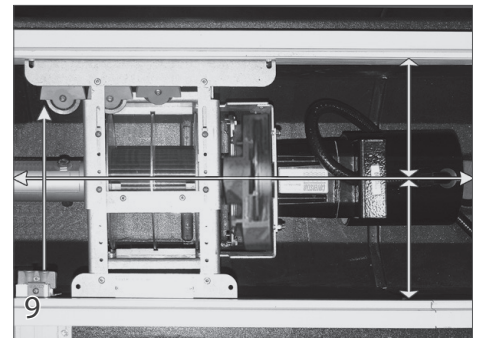

Position the mechanism in the cover box so that the roll-up tube is centered in the cover box front to back and properly aligned with the track. The rope should travel straight from the track to the pulley.

## Step By Step Instructions

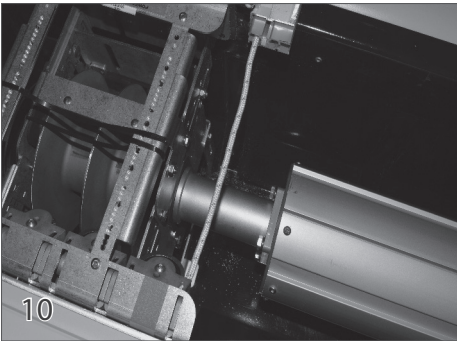

Align the mechanism on the motor side first by using a length of rope and extending it from the back side of the cover track to the pulley to make sure the rope will feed directly into the pulley.

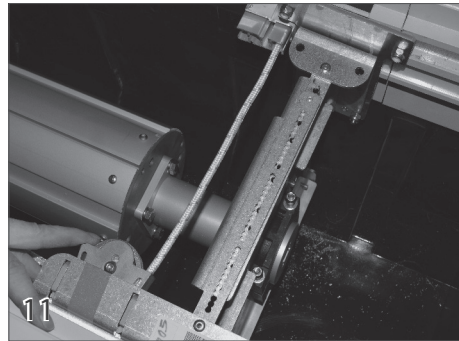

On the non-motor end, make sure the rope will travel straight from the track to the pulley.

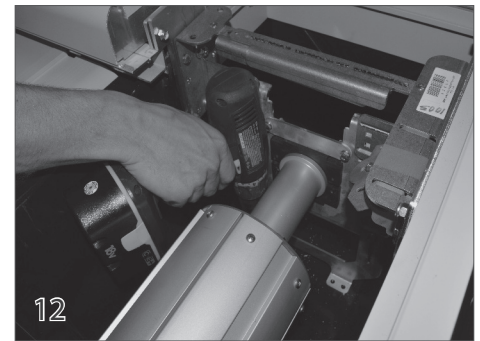

### Anchoring the Mechanism Feet

With the mechanism centered between the tracks and centered in the cover box front to back, anchor the mechanism mounting feet into the cover box. Use the appropriate screws and anchors depending on the type of cover box being used.

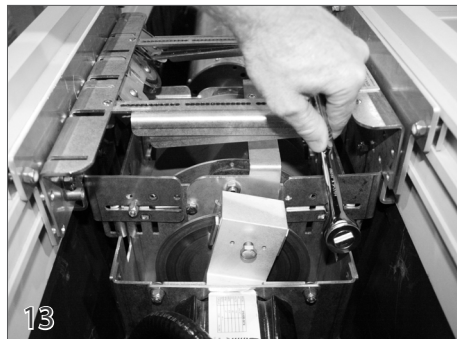

### Extending The Pulley Brackets

Loosen the nuts in the four positions on the adjustable brackets of the motor end of the mechanism. Spread the brackets outward against the walls of the cover box.



Raise the pulley brackets up so that the top of the bracket is even with the top of the encapsulation. This ensures the ropes will be level.

Tip: Before raising the pulley brackets, make sure the feet so the roll-up tube is as high as possible, while still allowing the clearance needed under the lid brackets for the cover.

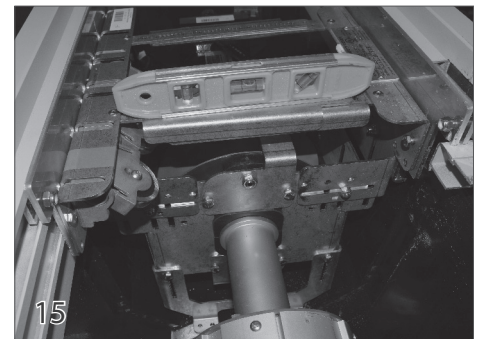

With the brackets in position, place a small level across them to make sure they are level. Tighten the four nuts on the adjustable motor end brackets.

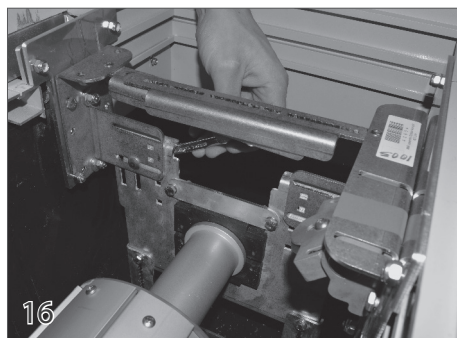

Loosen the bolts on the adjustable brackets on the non-motor end of the mechanism. Spread the pulley brackets outward against the walls of the cover box.

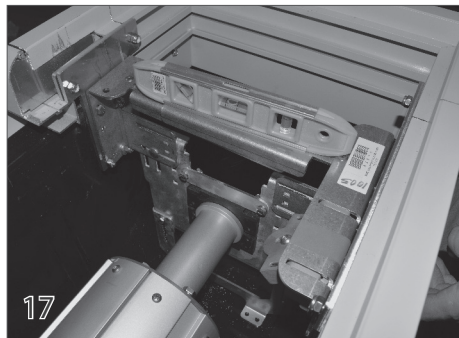

With the brackets on the non-motor end in position, place a small level across the brackets to make sure they are level. Tighten the nylock nuts on the adjustable brackets.



### Anchoring the Pulley Brackets

Anchor the motor mechanism brackets into the cover box in as many places as possible. Use the appropriate screws and anchors depending on the type of cover box being used.





## Electrical Wiring and Bonding

The automatic cover system must be bonded to meet the National Electrical Code. Bond both tracks to the mechanism by attaching a bonding lug to the guide feed screw and running a #8 solid copper bond wire to the mechanism. Bond the lid to the mechanism by drilling a hole in the lid at either end and attaching a bonding lug. Run bond wire from this lug to the mechanism. All brackets and any other metal over 4" long should likewise be bonded to the mechanism. There should be a bond wire extended from the equipment pad to the cover box, so it too can be attached to the mechanism. Note: Builder is responsible to bring proper electrical lines, conduit and bonding to the mechanism. Electrical wiring diagram and details are shown below.

On the motor and non-motor side, use the half inch screws (27) and nylock nuts (29) provided and secure the cross braces together.

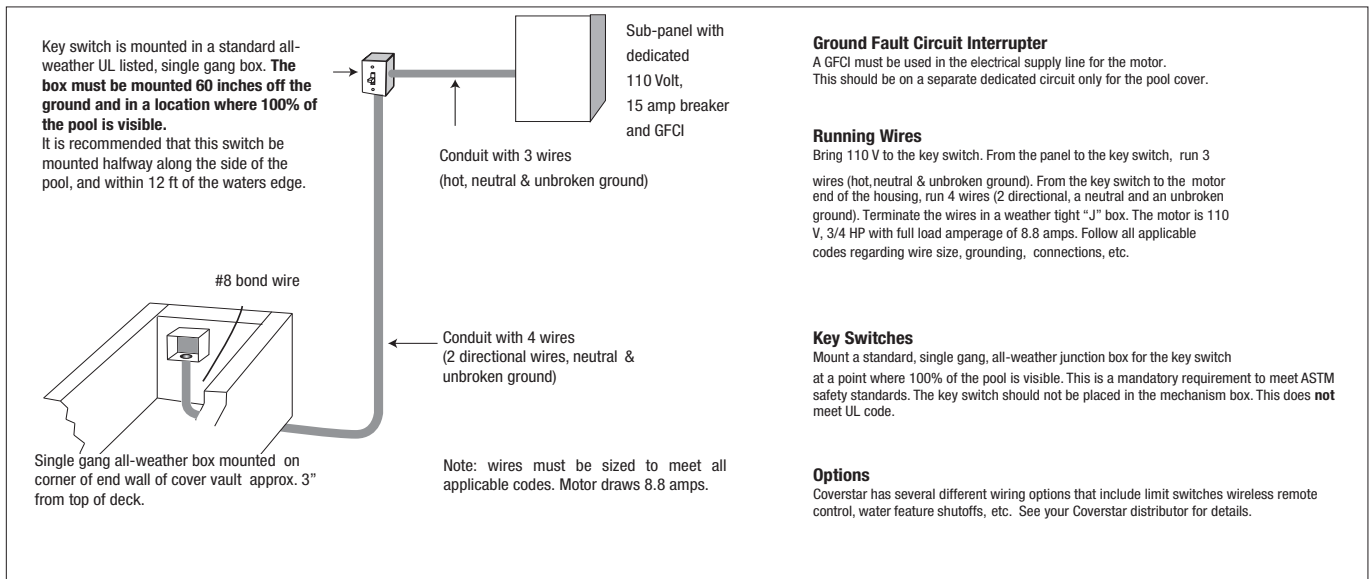

## Wiring the Electrical Switch

The control switch must be mounted in an all-weather box, in a location where 100% of the pool is visible. Connect the control switch according to the diagram below.

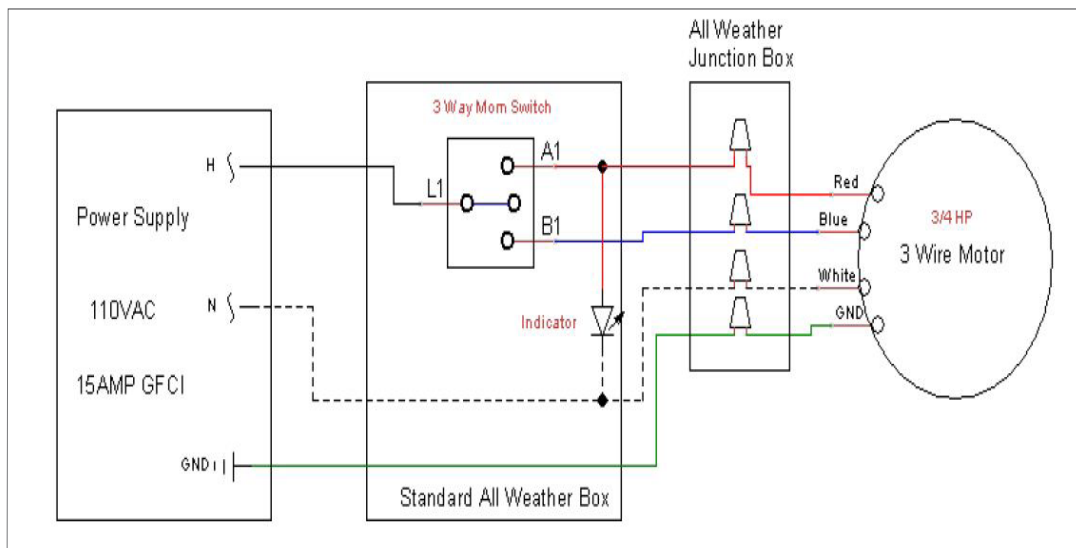





# COVER FABRIC

Step by Step Instructions	Page/ Step
Opening the cover box .....	11/1
Running ropes through the tracks.....	11/4
Installing the cover tracks .....	11/9
Routing the ropes .....	12/11
Inserting the Leading Edge .....	13/19
Encapsulation .....	13/25
Attaching the ropes to the reels .....	14/30
Running out the cover .....	14/34
Attaching the cover and bonding wire ...	14/35
 Mechanism Adjustments	
Rope Adjustments .....	15/38
Torque Limiter .....	15/41
Rope Reel and Non-motor end Brake .....	15/44

## Step By Step Instructions

Numbers in parenthesis refer to parts shown on page 3

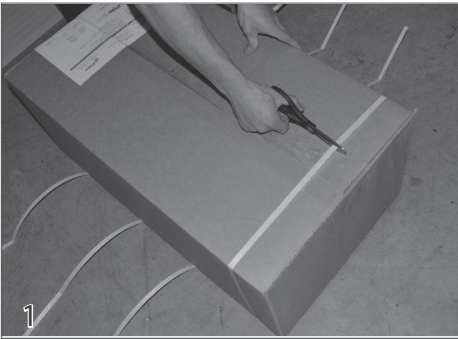

### Opening the Cover

To open the cover box, use scissors to cut the bands that hold the two halves of the box together. Never cut the top of the box open. Doing this could easily damage the cover inside. This kind of damage is not covered under the fabric warranty. With the bands cut, lift and remove the top box.



Standing behind the housing looking over the pool, unroll the cover from left to right. This will ensure the cover will be right side up when it is unrolled.



Uncoil the ropes to remove twists and kinks. Run the ropes through the tracks. There are two methods that can be used.



### Running Ropes in the Tracks

The preferred method of running the rope is to allow a short length of the rope to extend outside of the track. The portion of rope outside the track will be pulled as the rope is ran in the track.



Hold the rope outside the track and pull the rope along the length of track toward the end of the pool.



Feed the rope through the pulley (15) assembly. Insert the pulley with the rope onto the end of the track.



Pull the rope down the back side of the track toward the cover box.



### Alternate Rope Feeding Method

Another common method of running rope in the track is to pierce the rope with a small piece of wire. This wire then becomes the pulling handle as you feed the rope into the end of the track. This is especially useful if encapsulation isn't being used and the tracks are already installed.



### Install Track in the Encapsulation

Beginning at the shallow end of the pool, insert the track into the encapsulation. Lift the track so the tongue and groove between the track and encapsulation will interlock. Make sure the track extends 1" into the housing.



## Step By Step Instructions



10 Insert and tap the spacer into place underneath the track along the entire length of the track. Do this along both sides of the pool. The spacer needs to end at the inside edge of the cover box.

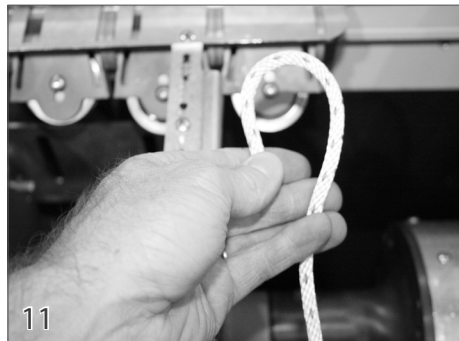

11 **Routing the Ropes**  
Begin on the motor end. Bend a small curve into the end of the rope.

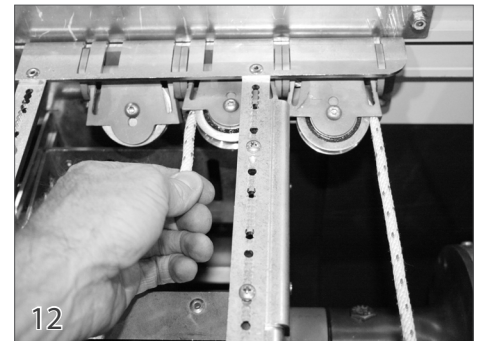

12 Insert the rope into the side of the first pulley. Push the rope behind that pulley and out along the far side of the second pulley.

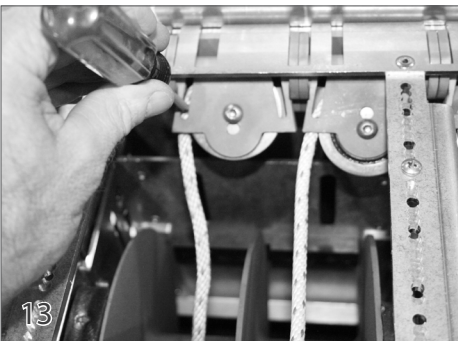

13 To help feed the rope around the pulleys, insert a small screwdriver into the slots in the pulleys and use it to help guide the rope.

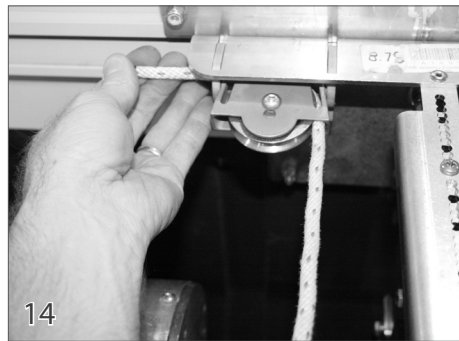

14 On the non-motor end, run the rope around the pulley and out the back channel of the pulley assembly. Pull this rope along the backside of the cover box to the motor end pulley assembly. Be sure to route the rope in front of the lid brackets.

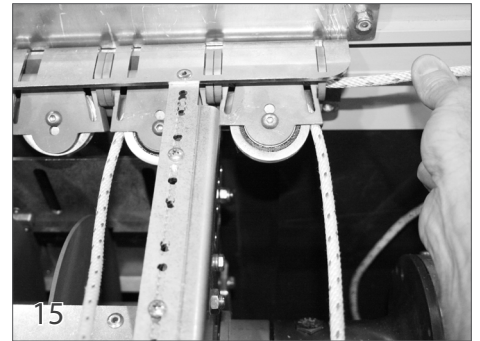

15 Insert the rope from the non-motor end into the channel behind the first pulley on the motor end. Push the rope behind all three pulleys and out of the channel behind the pulley.

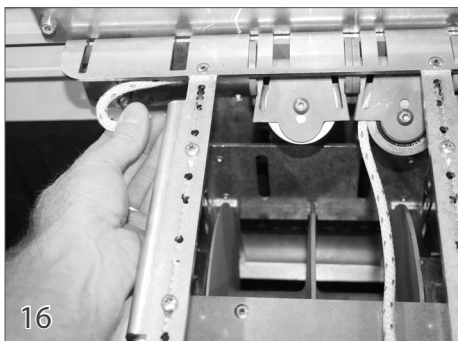

16 Bend a curve into the end of the rope and pull it back just until it is in the middle of the pulley. Now push the rope back until it comes out the side of the third pulley.

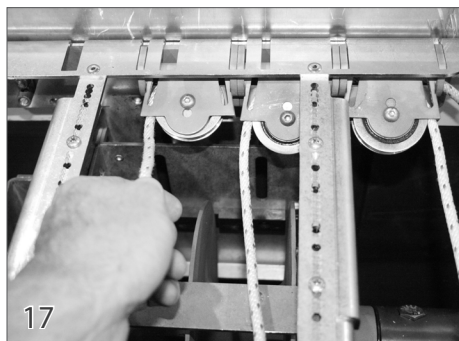

17 Continue pulling the excess rope through the pulleys.

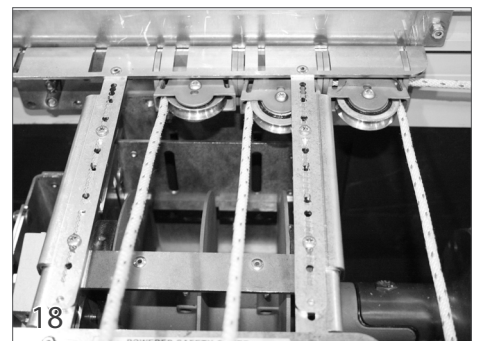

18 The ropes routed through pulley assembly should now look like this.



## Step By Step Instructions

Numbers in parenthesis refer to parts shown on page 3.



### Inserting the Leading Edge Tube

Lay the front of the cover across the bond beam. Slide the leading edge tube through the loop on the front of the cover. If the leading edge tube will remain exposed, slide the tube on to the bead on the front of the cover.



Place the nylon leading edge inserts into the ends of the leading edge tube. Make sure the inserts can slide freely inside the leading edge tube. If they don't, clean off any burrs that may be causing them to bind.



Secure the leading edge insert support bracket to the slider by placing the 10-32 x 1" screw up through the slider, through the hole in the front corner of the cover, and through the support bracket. Tighten completely using a 10-32 nylock nut, then back the nut off 1/2 turn.

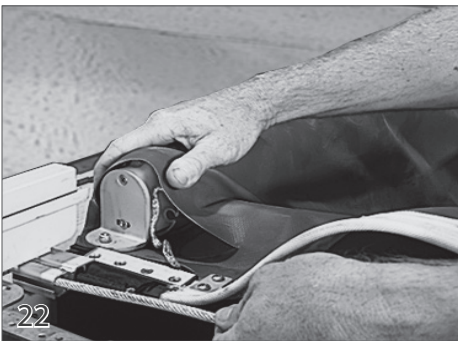

Pull the rope where it comes out of the track as you feed the slider and cover into the track. Keep pulling until the slider is in the track completely.



Use a 5/32" allen wrench to loosen the screw on top of the guide feed. Place the guide feed over the end of the track with the cover coming through one side and the rope through the other. Place a bonding lug (25) on a 10-32 X 1-3/4 screw (42) and insert the screw through the hole on top of the guide feed.



Use the allen wrench to tighten the screw that connects the two sections of guide feed together.



### Encapsulation

With encapsulation installed on the pool, and extended one inch into the cover box, it is used to keep the track from being pulled into the cover box.

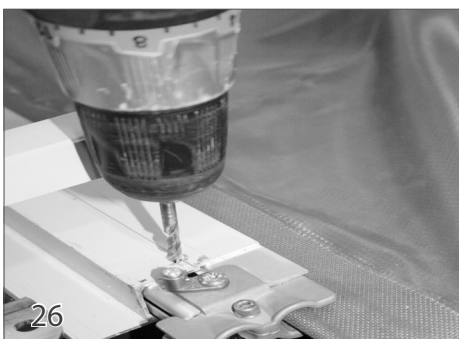

Drill through the center of the encapsulation and track. Insert a 10-32 x 1-3/4" screw (42) and nylock nut (29). This step is very important. (If the encapsulation was cut flush to the inside of the cover box, secure the track using a track retainer bracket (23)).



Run #8 copper bond wire (38) from the lug on each guide feed to the lugs on each end of the mechanism.

## Step By Step Instructions

Numbers in parenthesis refer to parts shown on page 3.



Connect the bonding wire that is attached to the front corner of the cover to the leading edge bar using a 10 x 1/2" tek screw (31). Be sure the screw doesn't interfere with the leading edge insert from moving freely inside the tube. Do this on both sides of the cover.



Position the fabric on the leading edge so it is in line with the leading edge support bracket. Secure with a 10 x 1/2" tek screw (31) on the back side of the leading edge tube. Be sure the screw does not interfere with the leading edge insert. Do this for both sides of the cover.



## Attaching the Ropes to the Reels

The cover must be open when cutting and attaching the ropes. Pull the cover back until the sliders are against the guide feeds. Pull the ropes tight as they come off the pulleys on the mechanism to eliminate the slack in the rope.



While pulling both ropes tight, use a lighter or torch to burn the rope in the location it will be cut. This will help them not fray after they have been cut. Cut the ropes so they are at least 8 ft long. In some cases you may only need to cut one rope. Use the lighter to re-burn the cut ends of the rope if needed.



Bring the ropes back to the mechanism. Attach the ropes to the rope reel by inserting the ropes through the center of the lugs and tighten the set screws firmly into the ropes. Some prefer to tie a knot at the end of the rope.

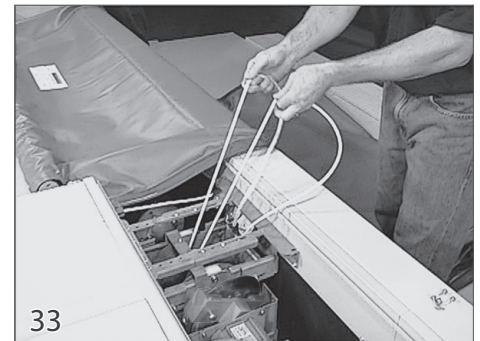

While holding the ropes over the mechanism, run the key switch in the cover position. As the excess rope is wrapped around the rope reel, make sure it goes on straight without getting crossed with each other.



## Running Out the Cover

Run the cover over the pool. Assist the cover as it is being pulled over the pool by helping unfold it and feed it into the cover track.



**Attaching the Cover & Bonding Wire**  
Make sure the webbing continues straight as it travels from the track to the roll-up tube. Attach the cover to the roll-up tube using tek screws (32). The first screw on each end of the tube needs to be 3 inches from the end of the tube. As the cover rolls up on the tube, the webbing will be rolling up over the cone.

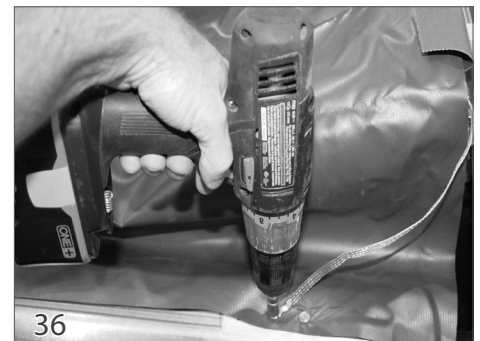

Lay the bond wire on top of the cover fabric. Secure it to the roll-up tube using a tek screw (32).



## Step By Step Instructions

Numbers in parenthesis refer to parts shown on page 3.



Distribute the slack of the cover evenly between each screw across the length of the tube. Secure the cover to the roll-up tube using tek screws (32) every 2-3 feet.



Run the key switch in the uncover position to roll the cover up on the roll-up tube. Check the cover to be sure it rolls up evenly. Run the cover 6-10 times to make sure it opens and closes evenly. The cover fabric installation is now complete.

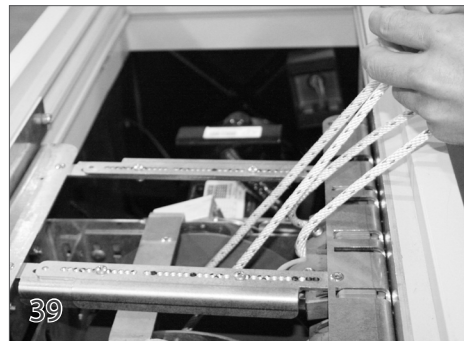

### Adjusting the Ropes

When closing the cover, if both sides of the cover don't close squarely, one of the ropes may need to be adjusted. To adjust the rope, open the cover all the way. Pull the excess rope off the rope reel.

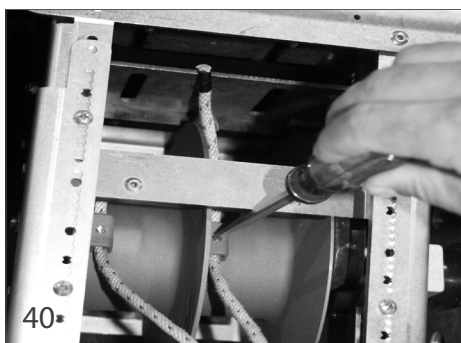

If one of the ropes is longer than the other rope, loosen the set screw that secures the rope to the rope reel lug. Shorten this rope until it is the same length as the other rope. Re-attach the rope to the rope reel.



If both ropes are the same length, and the cover doesn't close squarely, shorten the rope for the side of the cover that doesn't close all the way. The amount that the rope is shortened is equal to the distance that the cover needed to travel to close all the way. After shortening the rope, run the switch in the cover position while holding the ropes.



### Adjusting the Torque Limiter

The Eclipse Automatic Cover System is equipped with a torque limiter that helps prevent damage to the mechanism. Adjust the torque limiter so it is tight enough for the cover to operate correctly, but loose enough that it will slip as needed.

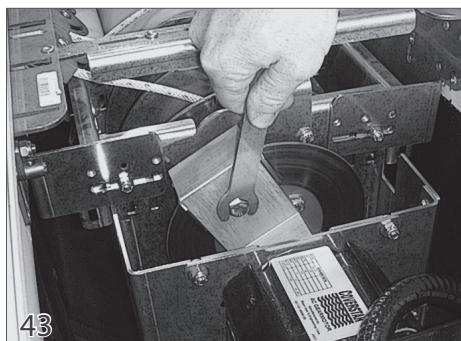

To adjust the torque limiter, use a 9/16" wrench to tighten the first torque limiter bolt 1/2 turn. Run the cover.

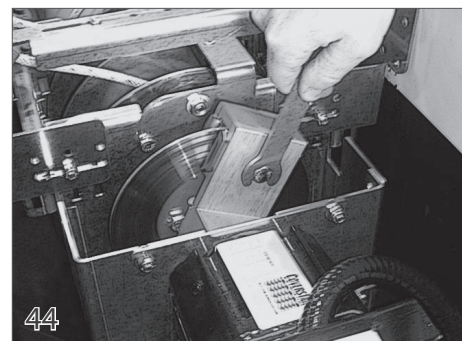

If further adjustment is needed, rotate the torque limiter brake arm to position the second brake bolt and tighten the second brake bolt 1/2 turn.

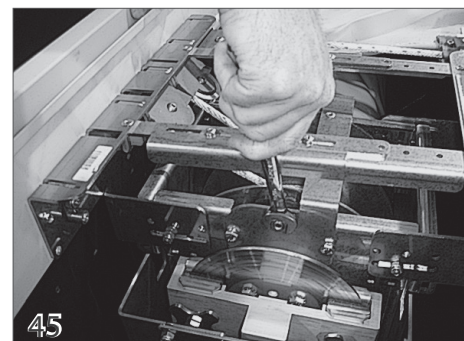

### Adjusting the Brakes

There is a brake at the motor and non-motor end of the mechanism. The brakes are preset at the factory and should work properly. If they do not, they should be tightened enough to prevent the rope from spooling off the reel as the cover is opening.



## Step By Step Instructions

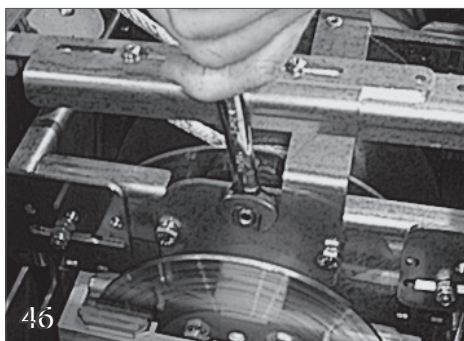

If you need to adjust the brakes, first loosen the jamb nut on the side of the rope reel mechanism.

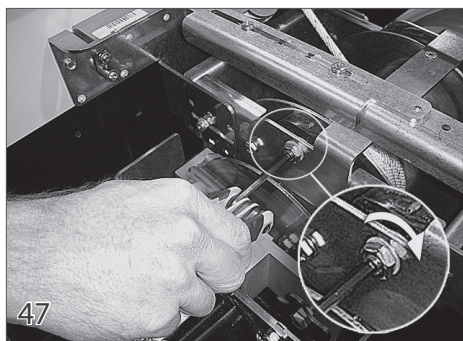

To tighten the brake, use a 3/16" allen wrench to turn the set screw inside the jam nut in the clockwise direction.

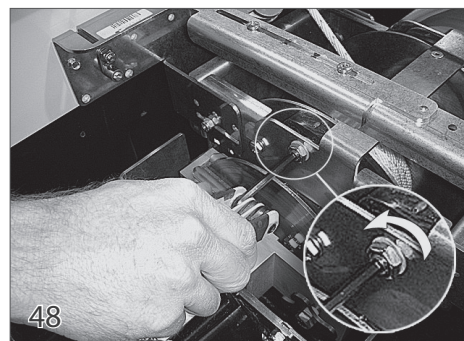

To loosen the brake, use a 3/16" allen wrench to turn the set screw inside the jamb nut in the counterclockwise direction.

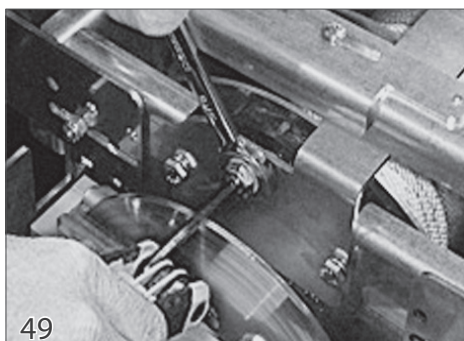

After adjusting the set screw, retighten the jamb nut while holding the set screw with an allen wrench. There's a corresponding brake on the opposite side of the rope reel. Adjust both brakes equally.

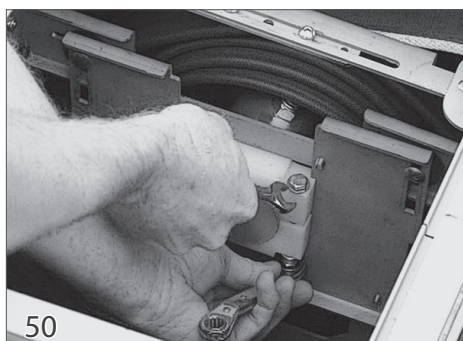

The non-motor brake should be tight enough to prevent the cover from rolling off the roll-tube faster than it is being pulled into the track. To adjust this brake, use two 7/16" wrenches to tighten or loosen the bolts in the brake block.

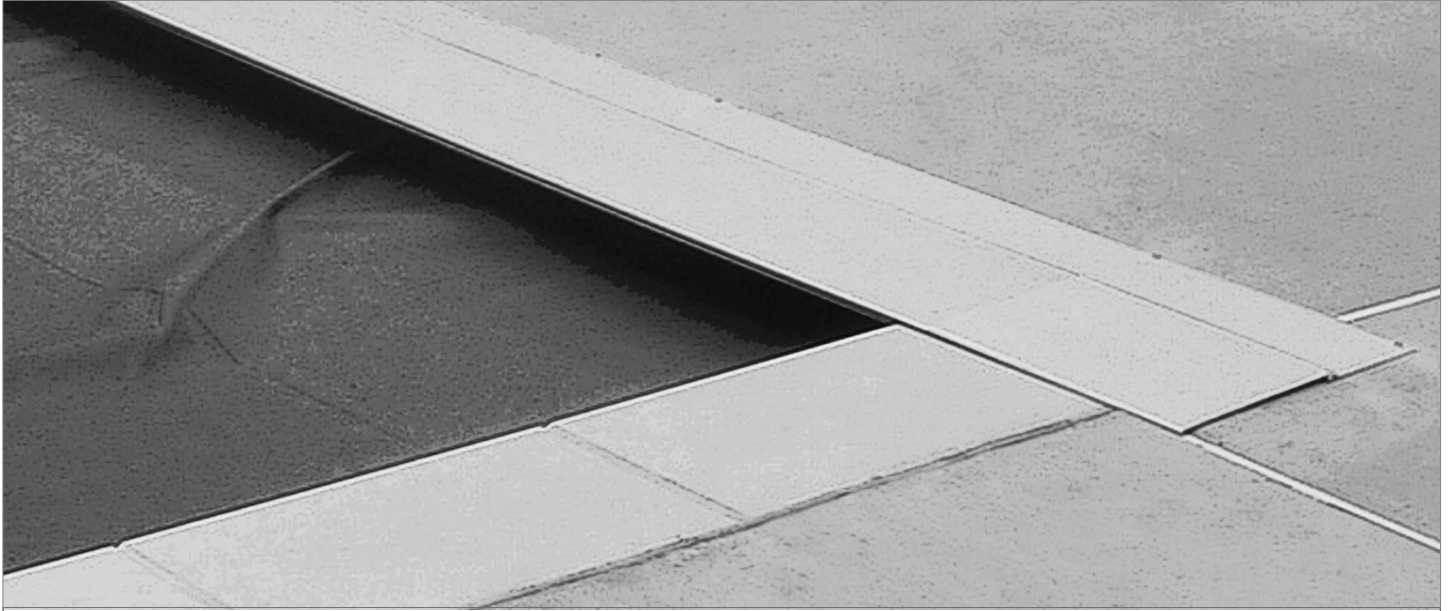

## CLASSIC ALUMINUM LID

Step By Step Instructions	Page/Step
Installing the lid brackets.....	18/1
Assembling the aluminum lid.....	18/4
Attaching the lid to the deck.....	18/7



## Step By Step Instructions

Numbers in parenthesis refer to parts shown on page 3.



### Installing the Lid Brackets

Space the brackets evenly across the back of the cover box. The brackets should be at least 10 inches from the cover track. Hold the bracket against the back wall of the housing so it is flush with the top of the deck. Use a 1/4" masonry bit and drill into the back of the cover box, at least 3 inches deep.



Insert plastic anchors in each of the holes that were drilled. Tap the anchors (33) with a hammer so they are in the hole completely.

Secure the brackets to the back wall of the housing using #12 x 1-1/2" hex head screws (34). Mount a rope loop (30) on one screw of each of the brackets. This will keep the rope running straight along the back of the housing.



### Assembling the Aluminum Lid

Assemble the lid by sliding the hinge onto the main section of lid.

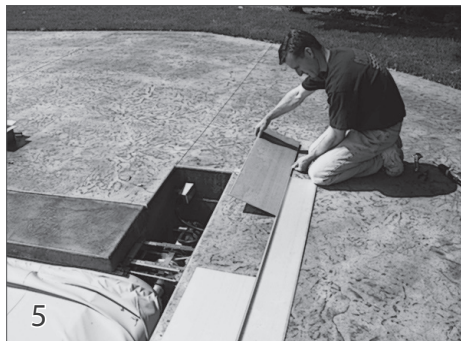

Slide the motor and non-motor lid ends onto the hinge.



Position the lid over the top of the housing. The motor end and non-motor ends should extend past the cover housing 1-2". If they extend more and do not lay flat on the deck, it may be necessary to cut the lids. Mark the lid with a square at the 1" overlap point and cut it to length with a hacksaw or power saw with carbide tipped blade.



### Attaching the Lid to the Deck

Drill through the lid hinge along the back edge every 2'-3' using a 1/4" drill bit. Then, drill through these holes and into the concrete deck using a 1/4" masonry bit.



Insert plastic anchors (33) into the holes and tap with a hammer so they are flush with the deck. Fasten the lid to the deck with #12 pan head screws (26).



Measure across the hinge to evenly space the screws. Continue drilling and anchoring the hinge in this manner until the entire lid is attached to the deck. The safety pool cover installation is now complete.



## HOMEOWNER CHECKLIST

After the cover system is installed, it is critically important to instruct the homeowner on how to operate the cover system safely and do routine maintenance. Use the following check list and the ECLIPSE Use & Care Guide as your primary instruction source.

### Use & Care Guide Page

- How to use the cover pump .....4
- How to uncover and cover the pool .....6-7
- Warn about standing water on the cover .....4
- Who is authorized to operate the cover system.....6
- Pool chemicals and cover life .....8
- Proper maintenance and care of the cover system...8-9
- Inform the customer on pool safety .....Back cover



# Installation Check List

## Tracks

- Does the track space measurement match how the cover system was ordered?
- All track ends filed. This is extremely important.
- Cover goes through the track joints smoothly.
- All track screws are tight and flush.
- Pulleys are flush against the end of the track.
- The guide feeds are snug against the track.
- Guide feeds bolted in and are tight.
- Stops installed.
- Alignment pins and splices used when joining the tracks, even in encapsulation.

## Mechanism

- Mechanism installed level in the box.
- Roll-up tube level in cover box.
- Tube centered between the tracks.
- Enough clearance top, bottom, sides for the fabric. No rubbing of webbing on sides or bottom of box.
- Tube at the right height? The ideal location is to install the cover in the box so that the cover is coming off at as small an angle as possible. This reduces stress on the mechanism and reduces wear on cover tracks at the end of the track.
- Tube either centered in the box or positioned slightly more towards the back of the box, so that the cover is unlikely to rub on front of the box.
- System mounted at right angle to the track.
- Ropes coming back straight out of the track. An excessive angle will cause wear on the cover tracks at the end of the track.
- Ropes are not rubbing on any brackets or the deck.
- Ropes are run correctly.
- 8 feet of rope left on rope reel.
- System bonded according to electrical code. Cover bonded to leading edge and roll-up tube.
- Make sure there is adequate drainage from the cover box.

## Cover

- Fabric pinned to the roll-up tube without pinned folds.
- Cover runs smoothly.
- Cover properly aligned when it closes or retracts. Note: An inch or two out of square is not uncommon and is not a concern as it will not affect the operation of the cover. Because of the size of the fabric roll and changes in operating conditions the cover may vary slightly in alignment as it is run.
- The leading edge inserts move in and out freely the whole length of the pool.
- Fabric is pinned to the leading edge flush with the ends of the tube.
- Cover not rubbing in the cover box as it rolls up.

## Cover Lid

- All sharp edges have been filed.
- All areas where the lid is not flat on the deck have been screwed down to eliminate any potential hazards.
- There is enough clearance between the lid brackets and the cover to avoid rubbing.

## Misc.

- Key switch is in full view of the pool.
- Cover pump tested by putting it in the water and operate it in front of homeowner.
- The cover box is clean and clear of debris so that the drains are not easily clogged.
- Pool area cleaned up.
- Homeowner has been instructed on the operation of the automatic safety cover system.